

INSTRUCTION MANUAL FOR THE NIPPY ST POSITIVE PRESSURE VENTILATOR



B & D Electromedical
35 Shipston Road,
Stratford-on-Avon,
Warwickshire. CV37 7LN

Tel: 01789 293460 Sales
01789 721577 Technical Support
Fax: 01789 262470
www.nippyventilator.com

NIPPY ST

INSTRUCTION MANUAL INDEX

	Page
Operation	
Description	3-4
Intended Use	5
Features	6
Explanation of Controls	7
Fascia Buttons	7-8
Fascia Display	9
Outlets	10
Rear Panel Layout	11
Explanation of Symbols Used	12
Getting Started	
The Main Screen	13
How to Adjust The NIPPY ST	13
The Menu Window	14
How to use the on-screen Menu	14
Structure of the Main Menu	15
How to use the on-screen help	16
Using Help with the Settings Locked	16
Breathing circuits and masks	17
Setting Up	
Setting up the NIPPY ST in CPAP Mode	18
Setting up the NIPPY ST in Pressure Support Mode	19
Alarm Conditions/Tests	
Mains Fail	20
High Pressure	20
Fault	20
Running on Battery Power	21-22
Connecting Auxiliary Equipment	23
Pneumatic Diagram	23
Specifications	24
International Standards	24
Operation Under Extreme Conditions	25
Accessories and Spares	25
Warnings and Cautions	26
Maintenance	
User Maintenance	27
Servicing	28
Warranty/Transportation	28
Factory Service / Repair	28
External Batteries	29-31
Locking the Settings	32

NIPPY ST Positive Pressure Ventilator

The Nippy ST is a pressure controlled, bi-level ventilator. It compresses ambient air and delivers it to the patient through a close fitting nasal mask. The output pressure, can be adjusted by controls on the fascia panel. The Pressure, and all settings are displayed on a colour LCD (Liquid Crystal Display) screen.

The screen can be set to dim after a pre-set time (accessed via the user preferences in the main menu). To restore the display, press any button once.

The basic ventilator settings can be achieved using the four buttons to the left of the display. The three buttons to the right of the display provide access to more advanced features and adjustments (accessed via a menu).

There are 2 modes of ventilation:-

- CPAP** (Continuous Positive Airway Pressure) Constant positive pressure is applied via the mask. No respiratory support is given in this mode.
- Pressure Support** IPAP (Inspiratory positive airway pressure) and EPAP (Expiratory positive airway pressure) are set by the physician. The ventilator augments the patient's spontaneous breathing. Ti is limited to half of the back-up period, up to a maximum of 1.5 seconds and minimum of 0.7 seconds.
If the patient's breathing rate falls to the back-up rate, a timed breath (Ti back-up) is initiated at the back-up rate.

Alarms

Power Fail If the electrical power to the ventilator is interrupted, an audible alarm will sound. This alarm will run for 5 minutes unless cancelled with the mute button. Once cancelled the power fail alarm will not re-activate.

Low External Battery When running on an external battery, the alarm will operate when there is approximately 10 minutes running time left. The alarm will also operate when the external battery self discharges to approximately 75% of its capacity during standby.

Low Pressure A pre-set low pressure alarm is provided. If the control pressure falls to below 50% of the set IPAP level for 10 seconds an audible and visual alarm will operate.

High Pressure A pre-set high-pressure alarm is provided. If the pressure rises above 120% of the working pressure, an audible and visual alarm will operate after a 2 second delay.

Breathing Circuit Disconnect A disconnect alarm is provided. This is activated by analysis of the inspiratory and expiratory flow waveform. An audible and visual alarm will operate.

Fault The alarm may also be operated by an internal fault. In this case the fault will be displayed on screen.

These alarms may be muted for approximately 2 minutes to allow for setting up of the ventilator.

Low Internal Battery An intermittent alarm (short beep) with no onscreen message indicates a depleted mains fail alarm battery. If the ventilator has been stored for more than a few weeks the internal battery will self discharge. In this case the alarm will stop after the battery has recharged.

The user cannot replace this battery. Refer to qualified technical personnel if the alarm operates when the ventilator is in daily use.

Estimated Tidal Volume

The estimated tidal volume is a calculated value, based on time and calibrated flow values. The constant leak through the breathing circuit exhalation port is subtracted from this calculation to give a reasonably accurate estimation of tidal volume. The estimated tidal volume is displayed above the bargraph display.

Inspiratory Trigger

The NIPPY ST employs flow triggering, detecting the start of the patients inspiratory effort when the flow rate exceeds the level set by the Inspiratory Trigger sensitivity.

Expiratory Trigger

The expiratory trigger is used in Pressure Support mode only. Towards the end of inspiration, when the inspiratory flow rate drops to the baseline (standing flow caused by exhale port leak) minus the expiratory trigger sensitivity the ventilator will cycle into the expiratory phase.

The inspiratory and expiratory effort required to cycle the ventilator can be adjusted via the Trigger option in the Menu.

For simplicity the trigger sensitivity is scaled 1 – 10, with 10 being the most difficult.

Intended Use

The Nippy ST is designed to augment ventilation in adults with acute or chronic type 2 respiratory failure.

Due to the patients requiring a certain level of respiratory drive, spontaneous mode ventilation is best suited to conditions of chronic ventilatory failure where high respiratory drive remains, these include:

- Chronic Obstructive Pulmonary Disease (COPD), Tuggey *et al.* (2003) found considerable patient benefits and cost saving to the NHS when using NIV in this group of patients.
- Morbid obesity.
- Severe obstructive sleep apnoea (OSA) where continuous positive airway pressure (CPAP) is not tolerated or where daytime hypercapnoea exists (Douglas 2002 and Simonds *et al.* 2001).
- Cystic fibrosis (CF).
- As a bridge to lung transplantation in end stage lung disease such as CF.
- Palliation of breathlessness in end stage lung disease such as CF and COPD (Holland *et al.* 2003).

Adjustment is carried out by medical staff. The patient only needs to fit the headset and nasal mask and switch on the machine. Patients with special needs, such as disabled or elderly persons, may require assistance when fitting the headset. The medical staff would assess the level of assistance required.

The ventilator is placed by the bedside and plugged into the domestic electricity supply.

Providing that a suitable socket outlet exists near the bed, no installation is required.

IMPORTANT!

This ventilator is not to be used for life support.

Nippy ST must be prescribed by, and used only under the supervision of a qualified physician.

FEATURES

1. Lightweight, compact fully self-contained unit
2. Comprehensive alarms with mute facility
3. User friendly intuitive software
4. Easily understood alarm messages displayed onscreen
5. 2 modes of ventilation
6. Employs state of the art microprocessor control
7. Universal mains input, operates anywhere in the world without transformers
8. Adjustable flow triggers with trigger indicators
9. Large, colour LCD display, clearly shows all settings
10. 28 days stored, On-screen compliance data
11. Fast trigger response
12. Very low maintenance requirements, therefore maintenance costs are extremely low.
13. Twelve months parts and labour warranty
14. Auto switching to back-up battery.
15. Automatic service reminder.

EXPLANATION OF CONTROLS

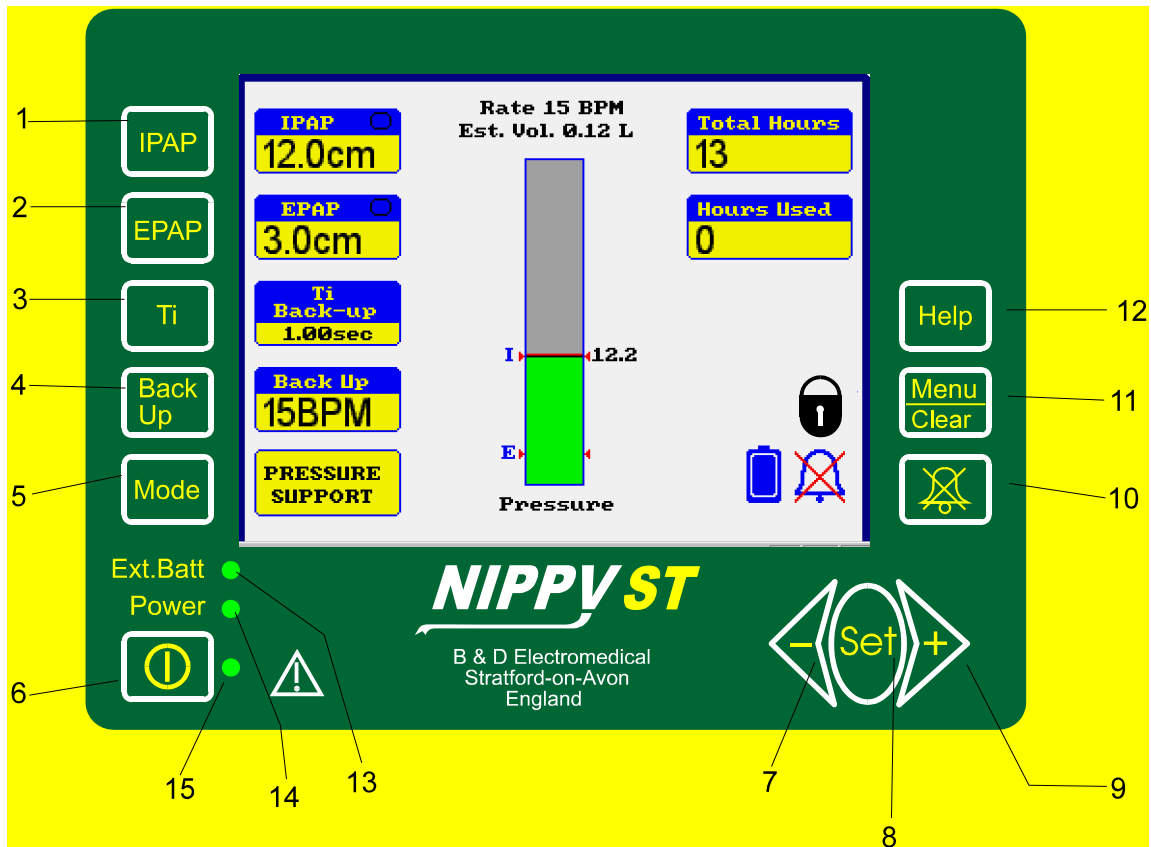



Fascia Buttons

1. **IPAP**
 - Selects the Inspiratory Positive Airway Pressure adjustment (scaled in cm H₂O). Value is displayed on screen adjacent to the switch.
2. **EPAP**
 - Selects the Expiratory Positive Airway Pressure adjustment (scaled in cm H₂O). Value is displayed on screen adjacent to the switch.
3. **Ti**
 - Selects the inspiratory time adjustment (scaled in Seconds). Value is displayed on screen adjacent to the switch.
4. **Back up**
 - Selects the Back-up Rate adjustment (scaled in Breaths Per Minute). Value is displayed on screen adjacent to the switch.
5. **Mode**
 - Displays the mode selection screen
6. **⏻**
 - Starts and Stops the ventilator
7. **◀-**
 - Decrements the selected parameter or moves the selection bar down the menu.
8. **Set**
 - Selects the current menu function displayed by the selection bar
9. **+▶**
 - Increments the selected parameter or moves the selection bar up the menu

- 10. Mute** - Silences the alarm for 2 minutes. Press and hold for 2 seconds to cancel alarm mute.
- 11. Menu** - Displays the menu screen
- 12. Help** - Displays context sensitive help messages.
- 13. Ext. Batt** - Indicates that ventilator is running from an external battery.
- 14. Power** - Indicates that mains power is connected
- 15. Start** - Indicates that the ventilator is running.

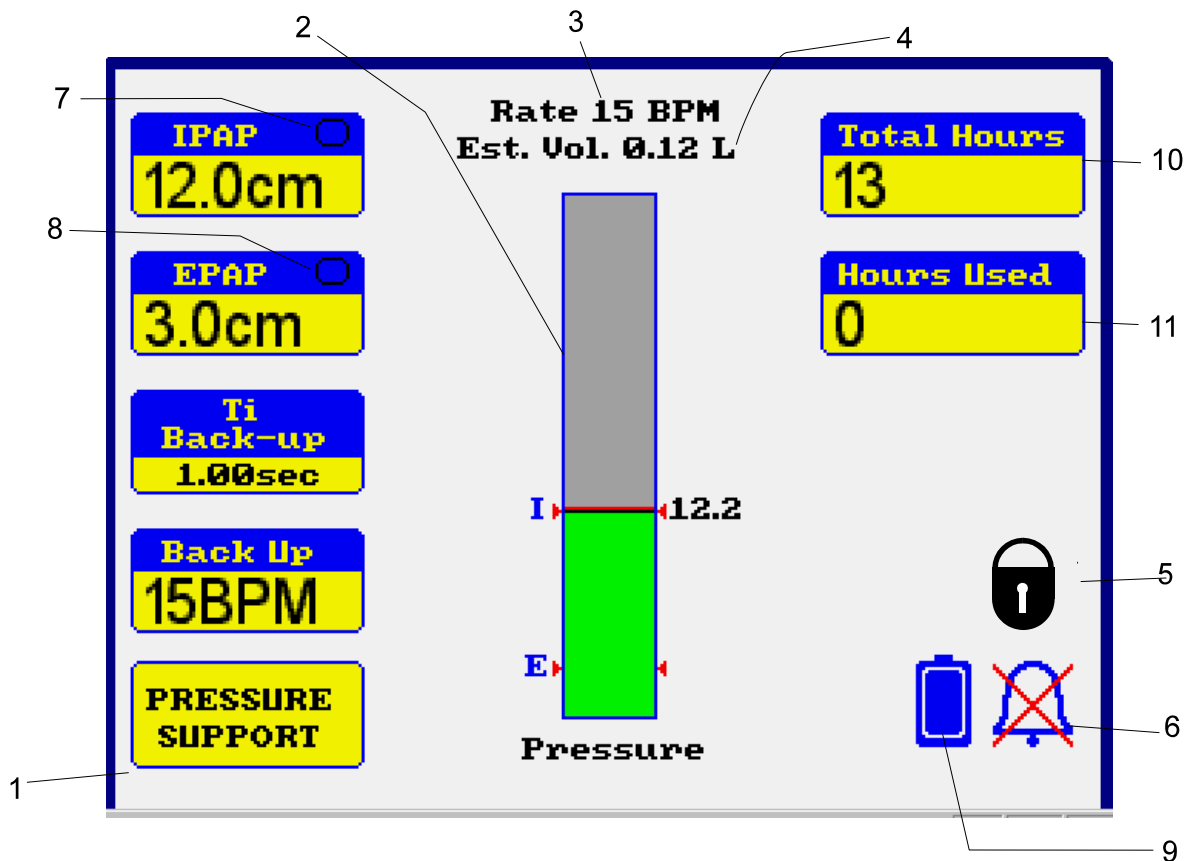
Fascia Display



- | | |
|----------------------------------|--|
| 1. Mode | - Displays current mode of ventilation. |
| 2. Pressure Display | - Indicates airway pressure (scaled in cm H ₂ O). Changes colour to red in under / over pressure alarm condition. |
| 3. Rate Display | - Indicates patient breath rate (scaled in Breaths Per Minute). |
| 4. Volume Display | - Indicates estimated inspiratory tidal volume (scaled in millilitres). |
| 5. Settings locked symbol | - This symbol shows that the settings are locked. |
| 6. Alarm Muted symbol | - This symbol shows that the audible alarm has been temporarily silenced. |
| 7. I Trigger indicator | - "Flashes" each time the inspiratory cycle is initiated by the patient. |
| 8. E trigger indicator | - "Flashes" each time the expiratory cycle is initiated by the patient. |
| 9. Auxiliary battery | - Indicates when external battery is connected. Changes to  when battery is low |
| 10. Total Hours | - Shows total machine running time. Used to determine service intervals |
| 11. Hours Used | - Shows total hours of use. (Compliance Hours) |

Ventilator Outlets









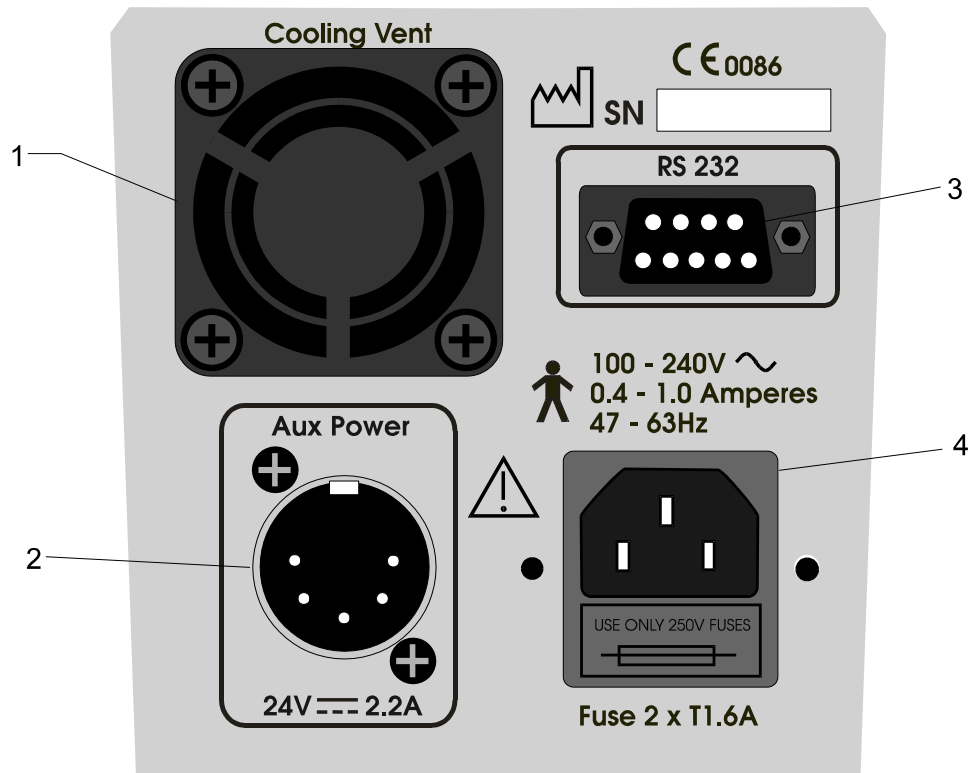











- 1. Outlet** - Main Air Outlet to breathing circuit

Rear Panel Layout

- 1. Cooling Outlet** - Reduces internal air temperature.
- 2. Aux. Power** - 24 Volt connection for external battery. Connect only recommended batteries, part nos 0787 and 0788
- 3. RS232 Port** - For connection to remote alarm or personal computer. Isolated to 1500 Volts.
- 4. Power Inlet** - Input mains power connector. Double fused and fitted with connector retaining clip.



Explanation of Symbols used on NIPPY ST and Accessories

	-	Type B Applied parts to EN 60601-1
	-	Alternating Current
	-	Direct Current
T	-	Time Delay Fuse
SN	-	Serial Number
	-	Date of Manufacture
	-	Attention. Consult Accompanying Documents
	-	Switch ON /OFF
	-	Increase Button
	-	Decrease Button
	-	Settings Locked / Unlocked
	-	Alarm Muted
	-	Alarm Active
	-	External Battery Connected
	-	Service Reminder
	-	External Battery Low
	-	Dispose of in Line with Local Authority Guidelines
	-	Recycle
	-	Do Not Reuse
	-	Batch code

Getting Started

To Switch On

Place the NIPPY ST on a clean, smooth, hard surface. (NOT carpet)
Connect the power lead to the mains power connector on the rear panel. Plug into the mains power supply.
Press the Start/Stop button.

To Switch Off

Press the Start/Stop button. The “Switch Ventilator Off” message will appear onscreen. Press the Start/Stop button again after 2 seconds. There must be a delay of 2 seconds before each push, to prevent accidental operation.

The Main Screen

The Main Screen is divided into 3 areas

The left-hand side shows the basic ventilator settings, IPAP, EPAP, Ti, BACK-UP, and Mode, adjacent to its setting button.

The centre section shows the airway pressure, estimated tidal volume and breath rate.

The right-hand side shows the Total hours, hours used and symbols for alarm mute and locked settings.

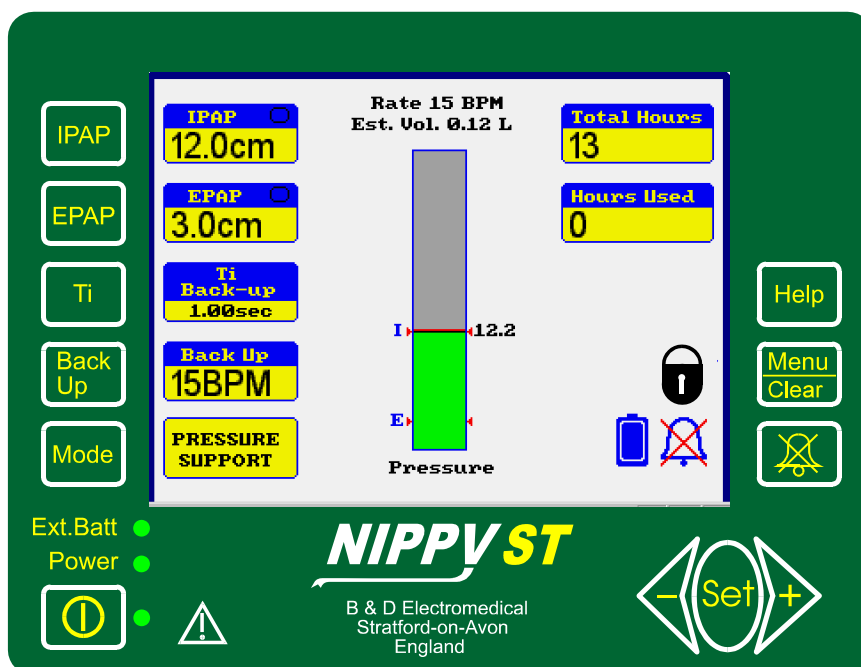

How to adjust the NIPPY ST

Select the desired parameter with the relevant button.

The reading adjacent to the button will be highlighted by a purple flashing box.

Alter it with the ◀- or +▶ buttons.

When you have finished, move on to the next adjustment or wait a couple of seconds for the flashing box to disappear.

E.g. Press IPAP.

IPAP setting will be surrounded by a purple flashing box.

Press +▶ to increase the pressure setting.

Menu Window

The Main Menu gives access to further adjustments and allows you to view information relating to the ventilator usage.

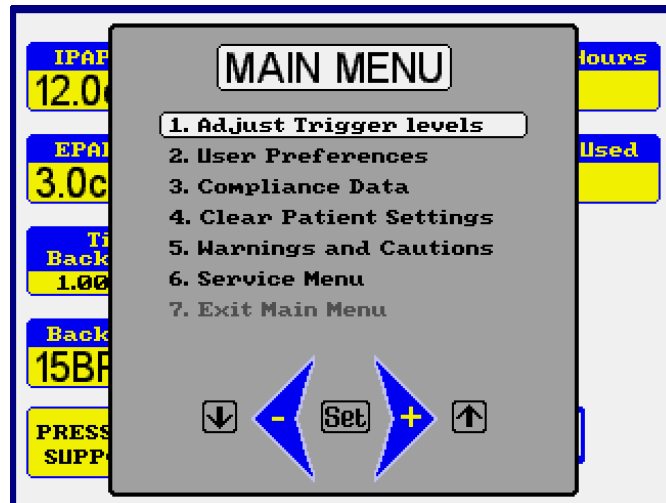

How to use the on-screen menu

Press the MENU button. The menu window will be displayed in front of the main screen.

Move the selection bar up or down the menu with the ◀- or +▶ buttons to highlight the desired function and press the SET button.

Follow the on-screen instruction at the bottom of the window

Press MENU at any time to exit and return to the main screen.

Eg.

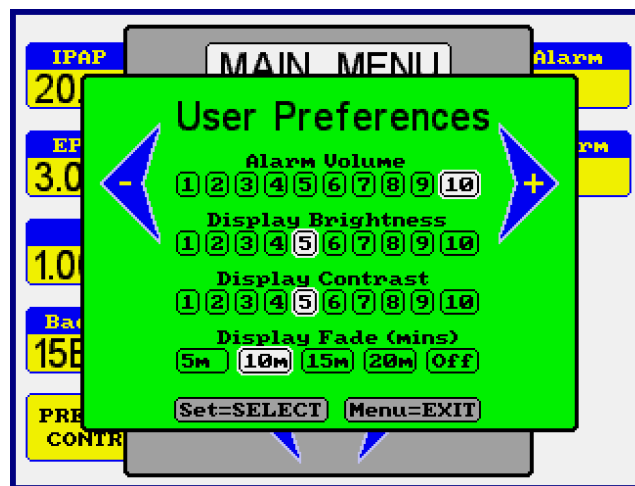

Press MENU.

Press ◀- button to move the selection bar over “User Preferences”.

Press SET. Press SET again to move the ◀- and +▶ symbols either side of “Display Contrast”

Press +▶ to increase contrast - Press MENU to exit.

Structure of the Main Menu

1. Adjust Trigger — I Trig — View / Adjust
E Trig — View / Adjust

2. User Preferences — Alarm Volume — View / Adjust
Display Brightness — View / Adjust
Display Contrast — View / Adjust
Display Dimming — View / Adjust

(Sets time in minutes until display dims, to night time level)

3. Compliance Data — Total Hours — View only
Compliance Hours — View only
Average Daily Use — View Only

Use + or – button to scroll through the data.

Press and hold + and – buttons to reset compliance data

4. Clear Patient Settings – Resets machine to default settings and resets the compliance data, ready for a new patient.

5. Warnings & Cautions — Safety information — View only

6. Service Menu — Service Information — Restricted Access

How to use the On-screen Help

Press the HELP button at any time for a list of help topics. Follow the simple on-screen instructions.



Press HELP again to exit.

If during setting up, you require a description of a particular parameter, select it then press HELP. Press HELP again to clear.

Using Help with settings locked.

When the settings have been locked, help is limited to a list of more common problems that may arise during use and advice on how to deal with them.

Follow the on-screen instructions

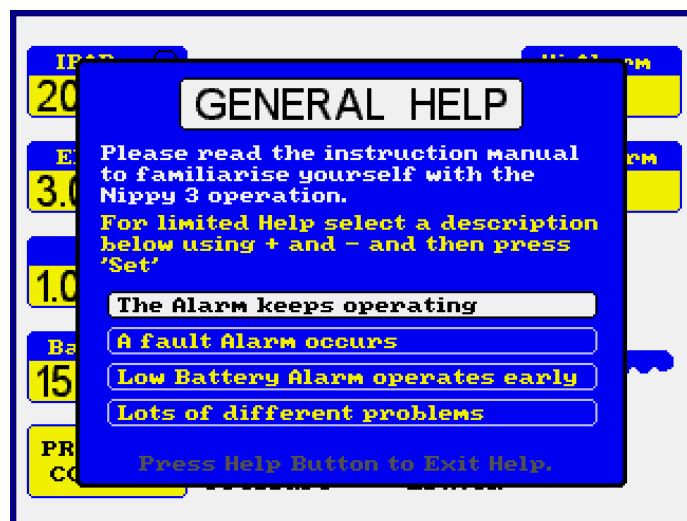

Breathing Circuits

Breathing circuits to be assembled in the order A-B-C-D from the ventilator end.

In **CPAP**, **Pressure Support** and **Pressure Control** modes, a single limb circuit with an exhalation port will be required. **DO NOT USE THIS TYPE OF CIRCUIT FOR IPPV MODE**

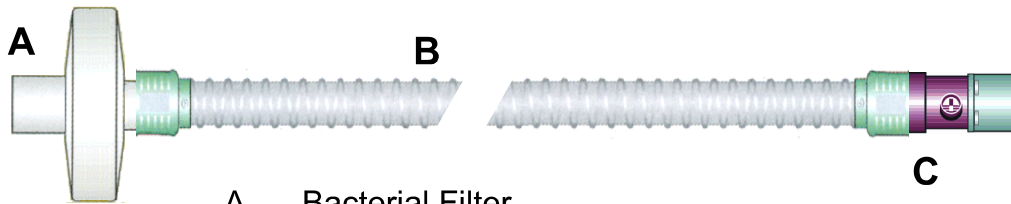

- A - Bacterial Filter
- B - Breathing circuit limb
- C - Exhale Port

Part Number 0792

Breathing circuit volume = 570 ml including filter.

SETTING UP THE NIPPY ST in CPAP MODE

1. Place the NIPPY ST on a clean, level surface.
2. Connect the breathing circuit tube to the outlet. It is recommended that a bacterial filter be fitted between the outlet and the 22mm diameter breathing tube.
3. Connect the mask to the outlet tubing on the breathing circuit.
Note: Do not fit the mask onto the patient at this point.
4. Press the Start/Stop button and select CPAP mode.
5. Carry out alarm tests as described in “Alarm conditions / tests”. **Note:** If any of the alarms fail to operate, **DO NOT USE** until the fault has been rectified.
6. Set EPAP to the prescribed pressure.
7. The patient may now **hold** the mask to the face.
8. Allow the patient to get used to the mask. Then strap the mask/headset to the patient.
9. Lock the settings to prevent unauthorised adjustment. See back page.
10. Disconnect the patient outlet port, before switching off.

SETTING UP THE NIPPY ST in PRESSURE SUPPORT MODE

Before starting to set up the ventilator, assess the patients breathing pattern. You will need to know the breath rate.

1. Place the NIPPY ST on a clean, level surface.
2. Connect the breathing circuit tube to the outlet. It is recommended that a bacterial filter be fitted between the outlet and the 22mm diameter breathing tube.
3. Connect the mask to the outlet tubing on the breathing circuit.
Note: Do not fit the mask onto the patient at this point.
4. Press the Start/Stop button and select Pressure Support mode.
5. Carry out alarm tests as described in "Alarm conditions / tests". **Note:** If any of the alarms fail to operate, **DO NOT USE** until the fault has been rectified.
6. Start with a low pressure to avoid distressing the patient. Set IPAP to around 8cm H₂O (or less for weak, frail patients). Set the EPAP to minimum (3 cm H₂O).

CAUTION: Avoid starting off with the pressure too high.

7. Ensure that the back-up rate is set to a lower value than that observed when assessing the patient.
8. The patient may now **hold** the mask to the face.
9. Allow the patient to get used to the mask. Then **gradually** increase the IPAP setting until the patient feels comfortable and is being ventilated efficiently. 10 to 20cm H₂O will suit most patients.
10. If the inspiratory or expiratory trigger needs to be adjusted, select "Adjust trigger level" from the menu and adjust to suit the patient.
11. Read the rate from the display (top of screen). This should match the value observed when assessing the patient. If the rate has increased, make sure that the trigger is not so sensitive that it is causing "self triggering". It may be due to the patient's anxiety at trying a new treatment. Stay with the patient while he / she settles down. When the rate has settled, set the Back-up to a value a few BPM below the patient's rate. Allowance should be made for a reduction in rate when the patient falls asleep.
12. Set EPAP if required. Then strap the mask/headset to the patient.
13. Check the rate when the patient is asleep. The inspiratory and expiratory trigger indicators should "flash" at the beginning of each breath.
14. Lock the settings to prevent unauthorised adjustment. See back page.

Disconnect the patient outlet port, before switching off.

Alarm Conditions/Tests

Test the alarms prior to use. Before testing alarms, ensure that the alarm is not muted. To cancel the Mute, press and hold the mute switch until a beep is heard (2 seconds)

Disconnect Alarm

If the breathing circuit becomes disconnected, the alarm will be activated.

To Test Switch on the ventilator and cancel the Mute. After 10 seconds the alarm will sound, accompanied by the on-screen disconnect alarm message.

Mains Fail Alarm

If the mains power to the NIPPY ST fails, the alarm will operate and continue for approx. 5 minutes. Press the mute button to silence the alarm.

To Test To ensure that the mains failure alarm is operating correctly, start the NIPPY ST and switch off the mains power at the wall socket. The screen will go blank after a few seconds and the alarm will sound. Press the mute switch or restore the power and re-start the ventilator to silence.

Low Pressure Alarm

If the IPAP pressure falls to less than 50% of the IPAP setting for more than 10 seconds, the alarm will sound and an on-screen message will warn of low pressure.

To Test It is not possible for the user to test this function.

High Pressure Alarm

If the airway pressure exceeds 120% of the IPAP setting for more than 2 seconds, the alarm will sound and the pressure display will turn red.

To Test It is not possible for the user to test this function.

Fault Alarms

The fault alarm indicates a fault in the machine. The on-screen message will indicate the nature of the fault. The message may be temporarily hidden by pressing the Mute button.

To Test It is not possible for the user to test this function.

If you receive a fault message at any time, DO NOT continue to use the ventilator. The machine MUST be referred to suitably qualified technical personnel for investigation/repair.

Running the NIPPY ST from an Auxiliary Power Source

If the mains power fails and there is no back-up battery connected, the NIPPY ST will switch off and sound the alarm. When mains power is restored, the NIPPY ST will automatically re-start.

To Back-up the Mains Supply

Place a fully charged back-up battery on the floor near the ventilator and connect it to the 24 Volt Aux Power input on the rear panel. If the mains power fails, the NIPPY ST will automatically switch over to battery power. The alarm will sound intermittently and a “Running on battery power” message will be displayed on the screen. Press the Mute button to acknowledge and clear the message and alarm. The Ext. Batt. light will continue to flash as long as the ventilator is running on battery power.

If mains power is restored whilst running on battery power, the NIPPY ST will automatically select mains power and the Ext. Batt. light will extinguish.

You must maintain the battery in a fully charged condition to get the maximum running time from it. All batteries self discharge over time. It will take approximately 4 - 6 months for a battery to discharge to 75% of its capacity.

If the battery becomes discharged during standby (running on mains power), the NIPPY ST will alarm and display a “ battery pack needs charging” message. Re-charge the battery as soon as possible. If you do not experience any power failures, you can expect to see this message once every 5 to 6 months.

If the battery is connected to its charger whilst on standby, the battery will be constantly charged while the mains supply is live. When the mains fails, the ventilator will switch to battery and back to mains power when it is restored.

When the battery becomes discharged during use (running on battery power), the Nippy 3 will alarm (two short beeps followed by one long beep) and display a “ low battery” message. Change to a fully charged battery and re-charge the flat battery as soon as possible. You can expect to see this message after approximately 4 hours running time.

If the voltage drops still further, due to a fault within the battery a “battery fault” message will accompany the alarm. Replace the battery.

Exchange it for a fully charged battery after it has been used for power backup or when the “charge battery” reminder is displayed on the screen. Keeping one battery connected to the ventilator and another on charge is a good way of being prepared for a power failure.

For Greater Mobility

The NIPPY ST may be powered from a small “mobility battery”. Connect it to the 24V Aux Power input and place it on the surface next to the ventilator. This gives approx. 2 hours running time on each battery.

When moving the ventilator and battery, do not allow the battery to hang on its cable. Always pick it up with the ventilator. If the battery is to be used to power the ventilator on a wheelchair or similar, secure the battery next to the ventilator. Self-adhesive hook and loop strips can be an effective means of securing.

When the NIPPY ST is connected to a charged mobility battery with no mains power, the ventilator will automatically select battery power in the same way as it would for a backup battery.

As with the backup batteries, it is important to keep the mobility batteries charged and ready for use. Recharge as soon as possible after discharge.

When the battery becomes discharged during use (running on battery power), the Nippy 3 will alarm (two short beeps followed by one long beep) and display a “low battery” message. Change to a fully charged battery and re-charge the flat battery as soon as possible. You can expect to see this message after approximately 2 hours running time.

If the voltage drops still further, due to a fault within the battery a “battery fault” message will accompany the alarm. Replace the battery.

Recommended batteries for use with NIPPY ST

- Back-up battery, part number 0787 – for power back-up. Approx. running time 4 hours at 30cm H₂O.
- Mobility battery, part number 0788 – for mobile use. Approx. running time 2 hours at 30cm H₂O.
- Use only the recommended batteries, part nos 0787 and 0788

See “external batteries” section for full instructions for use and care of these batteries

These batteries have their own special chargers. They are not interchangeable or suitable for any other types of batteries. See “battery care” section for full instructions.

Connecting auxiliary monitoring equipment

For monitoring or downloading data the NIPPY ST may be connected to a PC or Laptop computer. The NIPPY ST isolated RS232 port is safe for use with any domestic PC or laptop computer. However, when assembling a system, the completed system should comply with EN60601-1 (medical systems). For example, most computers do not comply with this standard, so it should be sited at a distance which makes it impossible to touch the computer and the patient at the same time.

The RS232 port may also be used to run a remote alarm unit.

Ventilator System Pneumatic Diagram

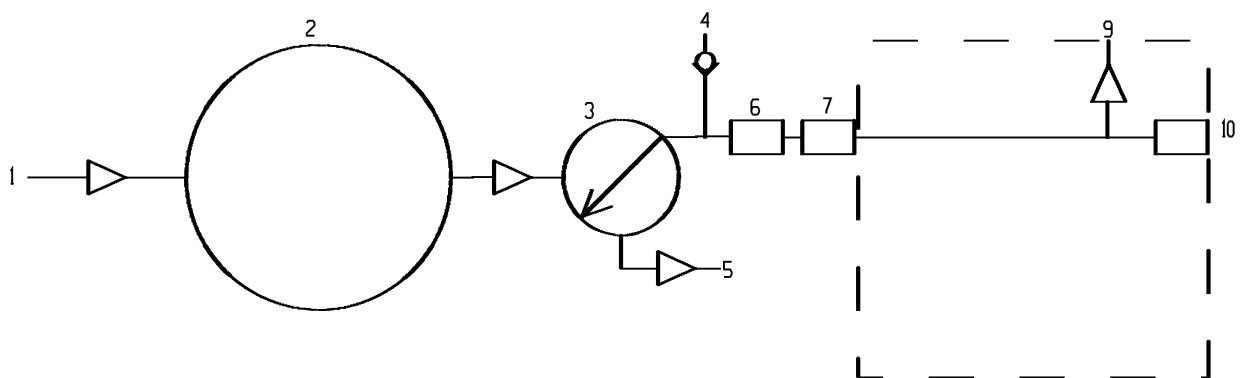

- | | |
|------------------------------|-----------------------------|
| 1. Fresh air inlet | 7. Outlet connector |
| 2. Blower (compressor) | 8. Breathing Circuit |
| 3. Servo Valve | 9. Exhalation Port |
| 4. Emergency fresh air inlet | 10. Patient Connection Port |
| 5. Exhaust | |
| 6. Flow Sensor | |

SPECIFICATIONS

Supply Voltage	-	100 - 240 V alternating current
Supply Frequency	-	47 - 63 Hz
Maximum Input Current	-	0.40 – 1.0 Amperes
Fuse Ratings	-	2 x T 1.6 A 20mm
Dimensions (mm)	Length - 297 Width - 223 Height - 132	
Weight	-	3.5 Kg
Ambient Operating Temperature	-	32° C 90° F Max
Digital Output	-	RS232 Isolated to 1500 Volts
All displayed readings expressed as	-	ATPD
Max. Output Pressure	-	30cm H ₂ O(36cm fault condition)
Calibrated pressure Range	-	0 - 30cm H ₂ O
Accuracy of pressure reading	-	+/- 3.0% F.S. +/-1% zero
Max. Output Flow	-	140 L/min. (unrestricted)
Max Volume Reading	-	2000 millilitres
Accuracy of volume reading	-	Estimated
Inspiratory Trigger	-	0.14 – 2.21 L/sec ²
Expiratory Trigger	-	0.28 – 1.67 L/sec ²
Inspiratory Time	-	0.7 – 3.0 seconds
Back-up Rate	-	6 - 43 Breaths per minute
Type of protection against electric shock	-	Class 1 equipment, Class 2 when powered by battery
Degree of protection against electric shock	-	Type B to EN 60601-1
Mode of operation	-	Continuous
IP rating	-	X0
Storage environment	-	-20 to 50°C 5 – 85% RH 260 – 1100 mBar atmospheric pressure
External back-up battery	-	24Vdc 7 Ahr
Running time	-	4 hours at max pressure
Mobility Battery	-	24 Vdc 4 Ahr
Running time	-	2 hours at max pressure
Protection against flammable anaesthetic mixtures	- Not suitable for use in the presence of a FLAMMABLE ANAESTHETIC MIXTURE WITH AIR OR WITH OXYGEN OR NITROUS OXIDE	

International Standards

BS EN60601-1 1990, EN 794-2

Safety of Electromedical Instruments, General Requirements

Electromagnetic Compatibility (In accordance with the EMC Directive 89/336/EMC)

B & D Electromedical declares that the NIPPY ST Ventilator complies with the following EMC standards. EN60601-1-2: 1993

Test results available for review from B & D Electromedical



Operation Under Extreme Conditions

Ambient Temperature in the range of +5 to +50 °C

Between 5 and 40 degrees functioning of the ventilator should not be affected. Extremes of temperature (below 5 °C, above 40 °C) may affect the colour of the LCD display. This will return to normal with the temperature. Operation above 40 degrees is not recommended. The ventilator may overheat at elevated temperatures. An audible and visual alarm will be activated in the event of over temperature. Air conditioning should be employed to keep the room temperature below 40 degrees.

Ambient Relative Humidity in the range of 10 to 100% RH

The ventilator is expected to function correctly at extremes of humidity. High humidity levels may affect the colour of the LCD display. This will return to normal with the humidity.

Atmospheric Pressure in the range of 600mBar to 1100mBar

The ventilator is expected to function correctly between 600 and 1100 mBar.

Supply Voltage Range from –20% to +10% of specified value

The NIPPY ST will operate normally

Failure of Electrical Power Supply

If a back-up battery is connected, the ventilator will automatically switch to the back-up supply and give an audible and visual indication that it has done so. During total power failure, there will be no output from the machine. The patient will be able to breathe spontaneously through the machine and out through the exhale port. To reduce the inspiratory resistance, a one way valve is fitted inside the machine, which bypasses the valve and blower. The inlet for this port is in the base of the machine. Always stand the NIPPY ST on a flat hard surface, to avoid obstructing the emergency air intake.

The inspiratory / expiratory resistance of the NIPPY ST and breathing system (NIPPY ST and circuit) is less than 6cm H₂O @ 60 l/min. This value must not be exceeded when adding attachments or fittings to the breathing circuit.

Accessories and Spares

1. A range of nasal and facemasks is available in various sizes. Please contact us for details
2. Head Set pt.no. 0563 available in Small, Medium, Large and Extra large. Please add S,M,L OR XL to part number when ordering.
3. A range of breathing circuits is available for use with nasal mask, facemask. See Breathing Circuits section, page 17.
4. Air Filter Element pt.no. 0584 (pack of 5)
5. Inline Bacterial Filter pt.no. 0635

These components are for single patient use.

6. Mobility battery, part number 0788
7. Back-up battery, part number 0787

WARNINGS

This ventilator is intended to augment the patient breathing. It **MUST NOT BE USED AS A LIFE SUPPORT VENTILATOR**. It is not intended to provide the total ventilatory requirement of the patient..

Do not attempt to pass oxygen into the panel mounted air inlet, or use with flammable anaesthetic agents e.g. Ether etc.

The NIPPY ST must be connected to a grounded (earthed) electrical supply. The protective earth of the domiciliary electrical installation shall be checked for safe and effective operation

CAUTIONS

- The NIPPY ST should only be used in accordance with the instructions of the supervising physician. **Personnel using and operating the NIPPY ST must become familiar with this instruction manual before using the unit.**
- Ensure patient safety through the presence of a trained attendant and an alternative means of ventilation. Consideration should also be given to the use of secondary alarm monitoring.
- The NIPPY ST should not be placed close to high frequency surgical diathermy, defibrillator or short wave therapy equipment as it may adversely effect the operation.
- The functioning of the ventilator can be adversely affected by electromagnetic interference exceeding the level of 10V/m in the test conditions of EN60601-1-2. . E.g. Mobile telephone operation may adversely affect the operation of the ventilator.
- If the NIPPY ST is moved from cold surroundings into a well-heated room, condensation may form. Do not operate the unit for at least 2 hours to allow any condensation to evaporate.
- Do not operate the ventilator in direct sunlight.
- Avoid places where there is excessive humidity or dust, which may cause damage to internal parts.
- Keep the NIPPY ST away from extreme direct heat, such as fires, heating radiators etc., and always allow a 100mm (4.0in) air space around the unit when in use.
- If liquids are allowed to enter the unit, serious damage could occur. If you spill any liquid into the NIPPY ST, consult qualified service personnel.
- Do not place any form of cover over the ventilator, especially near the air intake.
- DO NOT use anti static or electrically conductive tubing.
- **This range of ventilators was not designed for use with oxygen, therefore it is not recommended.**

USER MAINTENANCE

YOU MUST DISCONNECT THE NIPPY FROM THE MAINS SUPPLY BEFORE ANY MAINTENANCE IS CARRIED OUT

User maintenance is limited to cleaning and visual inspection of the ventilator, the input air filter and the breathing circuit.

The ventilator and the detachable mains cord set should be inspected for signs of external damage weekly. If any damage is evident (particularly to the mains cord set) refer repair to appropriately qualified technical personnel.

DO NOT immerse the ventilator in or spray with water

DO NOT use solvent cleaning agents or detergents

DO NOT use abrasive cleaning agents

Mains Power Lead

Before using the Nippy, inspect the mains lead for damage. Do not use if there is any damage to the plug, socket or the insulation.

Exterior of Case

To clean, wipe the exterior of the case with a soft cloth moistened with water.

Input Air Filter

The input air filter should be inspected weekly. It is located on the rear of the machine.

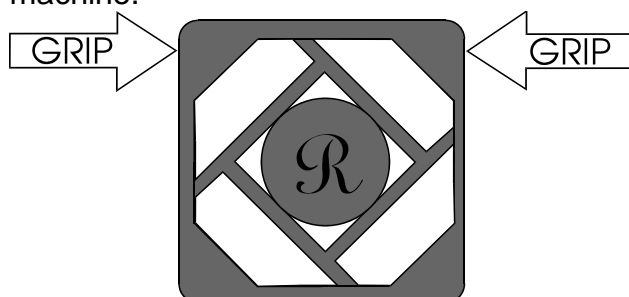

To remove the filter, grip the filter housing with the thumb and forefinger, across the top corners and pull the filter cover away from the ventilator. Remove and inspect the element. To clean the filter element, wash gently in tepid, soapy water. Rinse and allow the element to **dry**. When

the element is **dry**, place it back in the filter housing and refit the cover.

If the filter element requires replacement, use only recommended spares (see spares list). The use of any other filtering material may impair the performance of the ventilator.

Never attempt to clean the filter element with solvent cleaning agents.

Do not operate the ventilator unless the input air filter is in place.

Breathing Circuit Cleaning

The 22mm diameter breathing tube is considered disposable. If required it and the nasal mask may be cleaned by immersing in an anti-microbial sterilising agent, such as Milton fluid.

Servicing

Only suitably qualified technically competent personnel should attempt servicing of this ventilator.

To maintain its performance, the ventilator will require periodic servicing at the following intervals: -

Annual electrical safety test

10000 hours use. The service reminder symbol will be displayed on screen.

Details of service requirements are contained in the technical manual.

Technical Information

A technical manual incorporating circuit diagrams and descriptions will be made available, on request, to enable appropriately qualified technical personnel to repair the parts of the equipment designed to be repairable.

Warranty

The NIPPY ST is covered by a full 12 months parts and labour warranty, provided that the unit is properly operated under conditions of normal use. This warranty does not apply to any unit that has been subjected to misuse or accidental damage, or repaired or modified by unauthorised personnel.

Transportation

When shipping, damage as a result of inadequate packing is the customer's responsibility. Use the original packing materials whenever possible.

In the event of a breakdown or damage to the ventilator, refer servicing or repair to qualified and competent technical personnel.

Factory Service / Repair

B & D Electromedical products returned for factory service or repair must have a Return Material Authorisation (RMA) number assigned. This is essential for efficient processing of repairs.

You can obtain your RMA number by calling 01789 293460 with the following information:

1. Unit Model
2. Serial number
3. Your name, address and telephone number
4. Complete description of the malfunction or service required

When the RMA number has been issued, we will arrange for the unit to be collected. Place the RMA number on the outside of the carton.

The unit must be properly packaged before shipment. Preferably, in the original packaging.

B & D Electromedical are not responsible for inbound transit damage.

When enquiring about a returned item, you must quote the RMA number.

Disposal at end of Life

The NIPPY ST should be disposed of in line with local authority guidelines / regulations.

Spent batteries should be returned to B & D Electromedical.

External Batteries

Two batteries are available for running the NIPPY ST.

Back-up battery, part number 0787.

Mobility battery, part number 0788.

Each has its own dedicated charger.

Mobility battery charger part number 0796

Backup battery charger part number 0797

It is not possible to charge one from the charger of the other.

These batteries should never be used to run any other type of equipment.

Instructions For Use

- Connect the battery to the NIPPY ST Aux Power input.
- The Power light will illuminate.
- Switch on the NIPPY ST. The Ext Batt light will flash and a “Running on battery power” message will be displayed on the NIPPY ST screen. Press the alarm mute button to hide the message.
- To disconnect a battery: Always switch off the ventilator first. Press the plug release button on the connector and withdraw the connector.

To Charge a Battery

- Place the charger on a smooth flat surface.
- Connect the charger to the battery socket **before switching on the mains power**.
- Connect the mains plug to the AC supply and switch on.
- Leave on charge until the charged / ready indicator lights.

Batteries may produce explosive gases during charging. Always charge away from sparks or sources of ignition. Do not smoke near a battery whilst charging.

Disconnect the mains power before disconnecting the battery from the charger.

Back-up batteries may be left connected to the charger until required for use.

Mobility batteries should be charged then disconnected from the charger. Re-charge if not used within 1 month.

Safety

Warning! High voltages exist inside the charger.

Do not remove the cover. Return to B & D Electromedical if a fault occurs.

Do Not expose to water or dust.

Do not cover the charger whilst in use

Ensure that the mains lead is not damaged.

Do not attempt to charge any other type of battery with it.

Battery pack cleaning

To clean, wipe the exterior of the case with a soft cloth moistened with water.

Battery Care

DO NOT use an ordinary car battery charger. This type of charger may damage the battery and will almost certainly shorten its life.

- The battery should be recharged as soon as possible after use.
- This type of battery does not suffer from the memory effect that is widely talked about and does not need to be fully discharged before charging.
- Batteries like to be used. A new battery may require several charge/discharge cycles before it reaches its maximum performance. The same applies to a battery that is only used occasionally with long periods in storage.
- The performance of all lead-acid batteries falls with temperature. The times stated below refer to ambient charging and operating temperatures of 20°C.

Battery Life

The end of life is defined by the maximum running time falling to 75% of that of a new battery. For a battery that is used occasionally service life is 2 years. Replace the battery when running times drop below those indicated or after 2 years.

RUNNING TIMES

Back-up Battery

The following relate to charging and discharging at 20°C. The minimum times represent a battery at the end of its life and the typical times should be achieved by a good battery.

Working Pressure

	15cm		20cm		30cm	
BATTERY	MIN	TYP	MIN	TYP	MIN	TYP
0787	3h 24m	4h 30m	3h 12m	4h 15m	3h	4h

The battery is fully discharged when the Nippy Junior low battery alarm sounds and the on-screen Low battery message is displayed.

Mobility Battery

The following relate to charging and discharging at 20°C. The minimum times represent a battery at the end of its life and the typical times should be achieved by a good battery.

Working Pressure

	15cm		20cm		30cm	
BATTERY	MIN	TYP	MIN	TYP	MIN	TYP
0788	2h 15m	3h	1h 50m	2h 30m	1h 30m	2h

The battery is fully discharged when the Nippy Junior low battery alarm sounds and the on-screen Low battery message is displayed.

Battery Storage

This type of battery must always be fully charged before storage.

A battery that is not in use will slowly discharge. This rate of discharge increases with temperature. Ideally the storage temperature should be above -20°C and below 20°C . It must be below 40°C .

After storage in a cold environment allow 24 hours for the battery to reach room temperature before use.

Fully charge the battery every 2 months.

Battery Test

Test the battery if the running time seems low, a fault is suspected, or to confirm that the battery is good.

- Ensure the battery is fully charged.
- Run the ventilator from the battery until the low battery alarm operates and record the running time. Look up run time in the table. If the battery is not achieving minimum run time replace it.
- If the battery is good, fully recharge it immediately after testing.

Hints and Tips For Reliable Operation

- Always make sure that the battery is fully charged before use.
- Do not switch off charger until battery is fully charged.
- Avoid the temptation to give the battery “a quick boost”. This is of no benefit.
- If you are in doubt about your battery’s state of charge, charge for at least 24 hours.
- If running time suddenly seems considerably shorter than normal, make sure that the battery is fully charged.
- Do not charge your battery near sources of ignition.
- Check the running time of your system from time to time.
- If you have more than one battery, use them in rotation.
- Do not use if any of the cables or components show any sign of damage.
- Most reported problems arise from incorrect battery charging.

Disposal of depleted batteries

Return depleted batteries to B & D Electromedical or dispose of them in line with local authority regulations.

Locking the settings

The settings can be locked to prevent unauthorised adjustment.

To lock - press ◀- and +▶ buttons simultaneously and hold for 2 seconds.

To unlock - press ◀- and +▶ buttons simultaneously and hold for 2 seconds.

This page may be removed before the instruction manual is passed to the user.